

Upphovsrätten till detta dokument och alla bilagor anförs till mottagaren personligen, den förblir alltid Inwido AB:s (556633-3828) egendom. Att kopiera eller på annat sätt reproducera detta dokument till tredje part utan skriftligt tillstånd är strängt förbjudet.

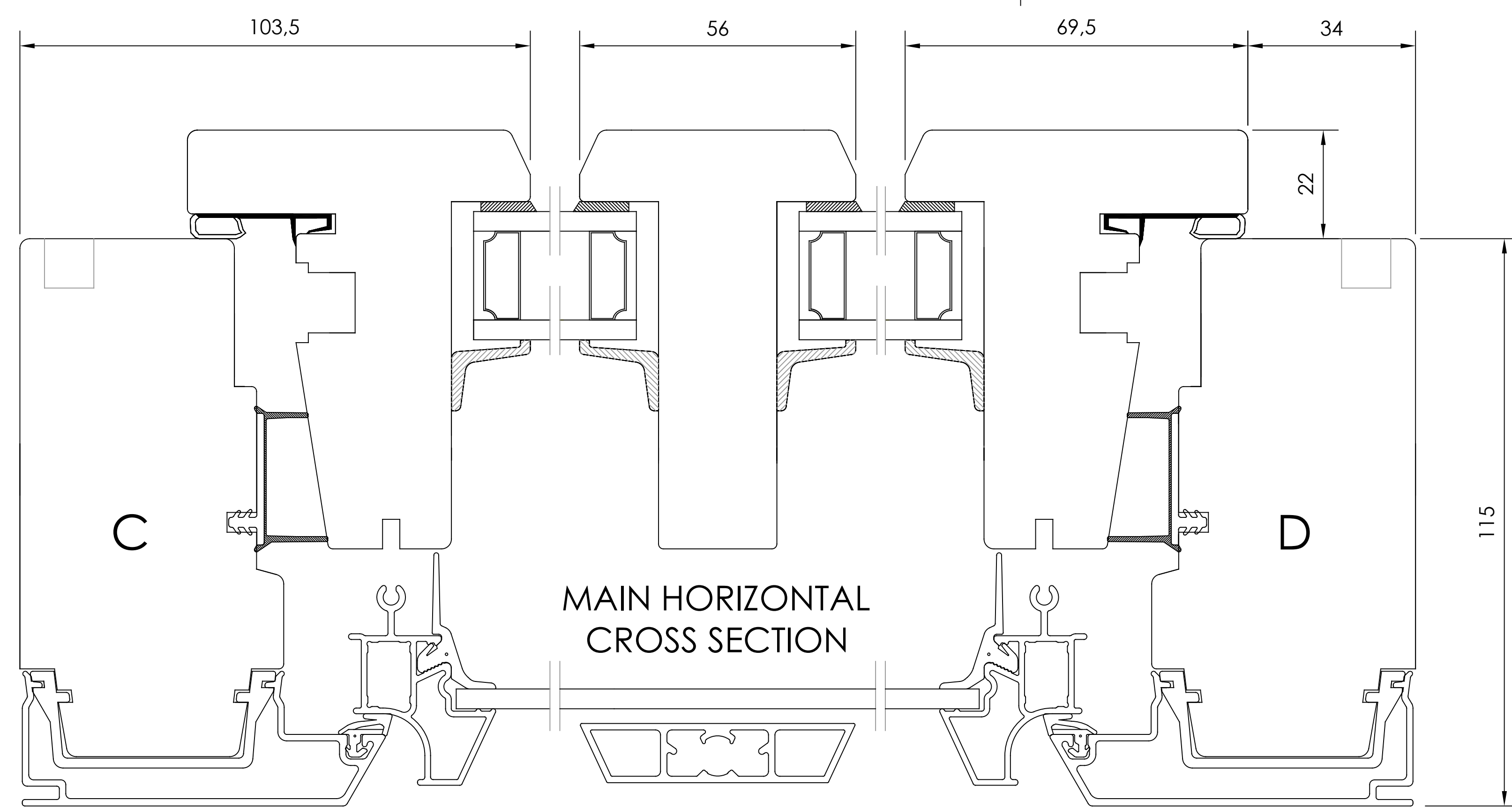

**VARIANT, FITTINGS**

- Exterior hinges.
- Exterior tilt before turn hinges (kipp-dreh).
- Internal hidden tilt before turn hinges (kipp-dreh).

**ALL AROUND OPTION**

- Internal slot (not for exterior kipp-dreh).

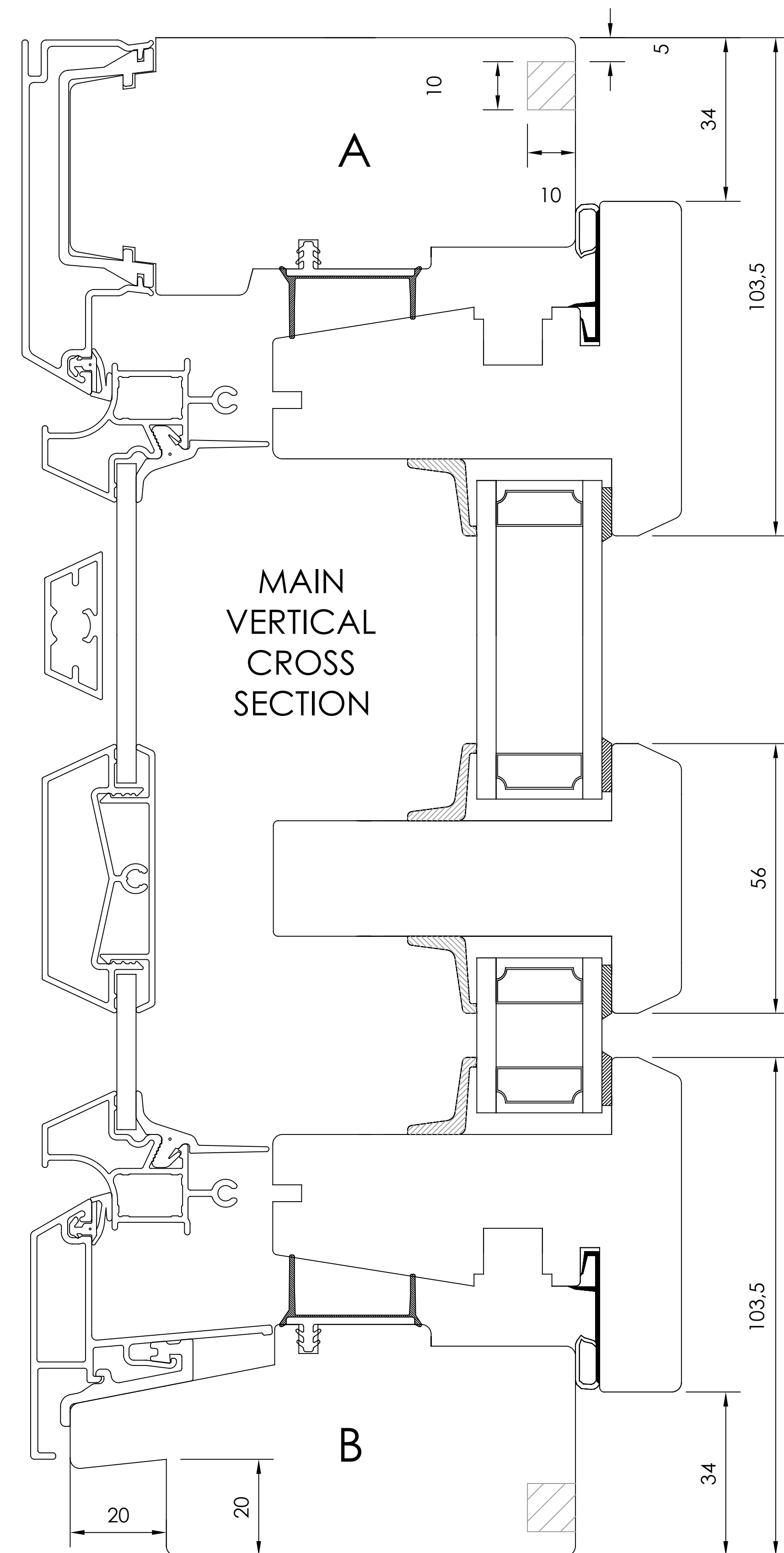

**MAIN VERTICAL CROSS SECTION**

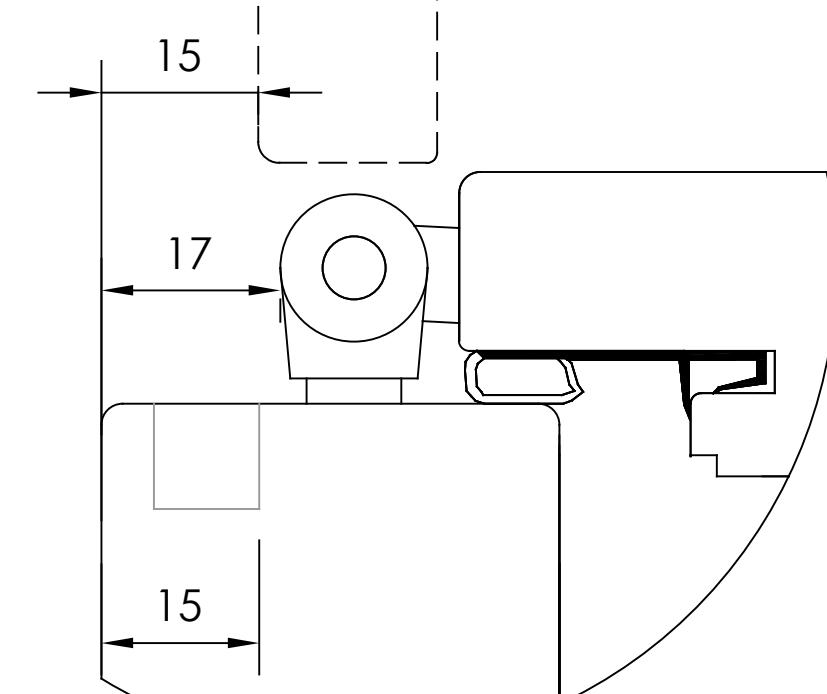

- Exterior hinges

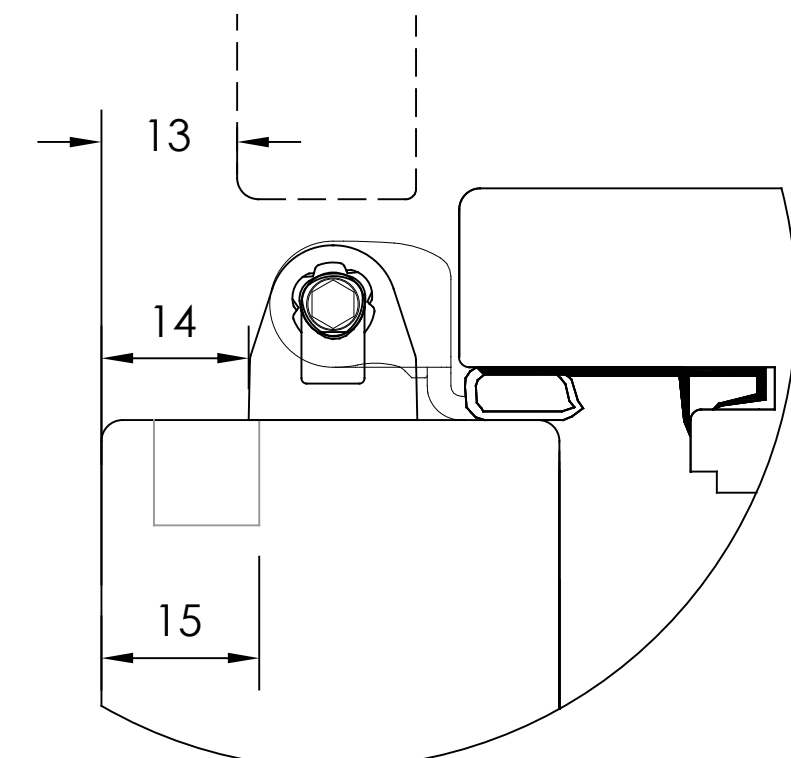

- Kipp-dreh hinges

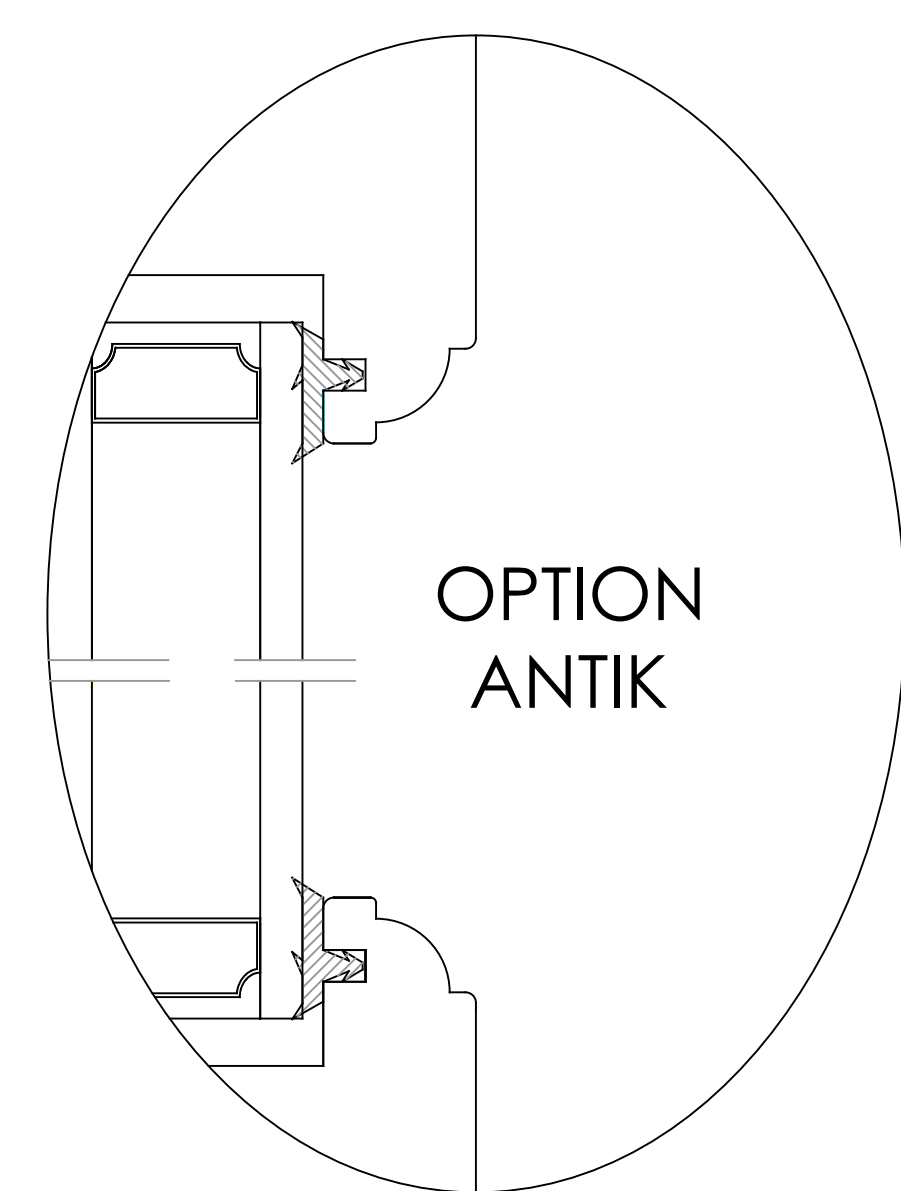

OPTION ANTIK

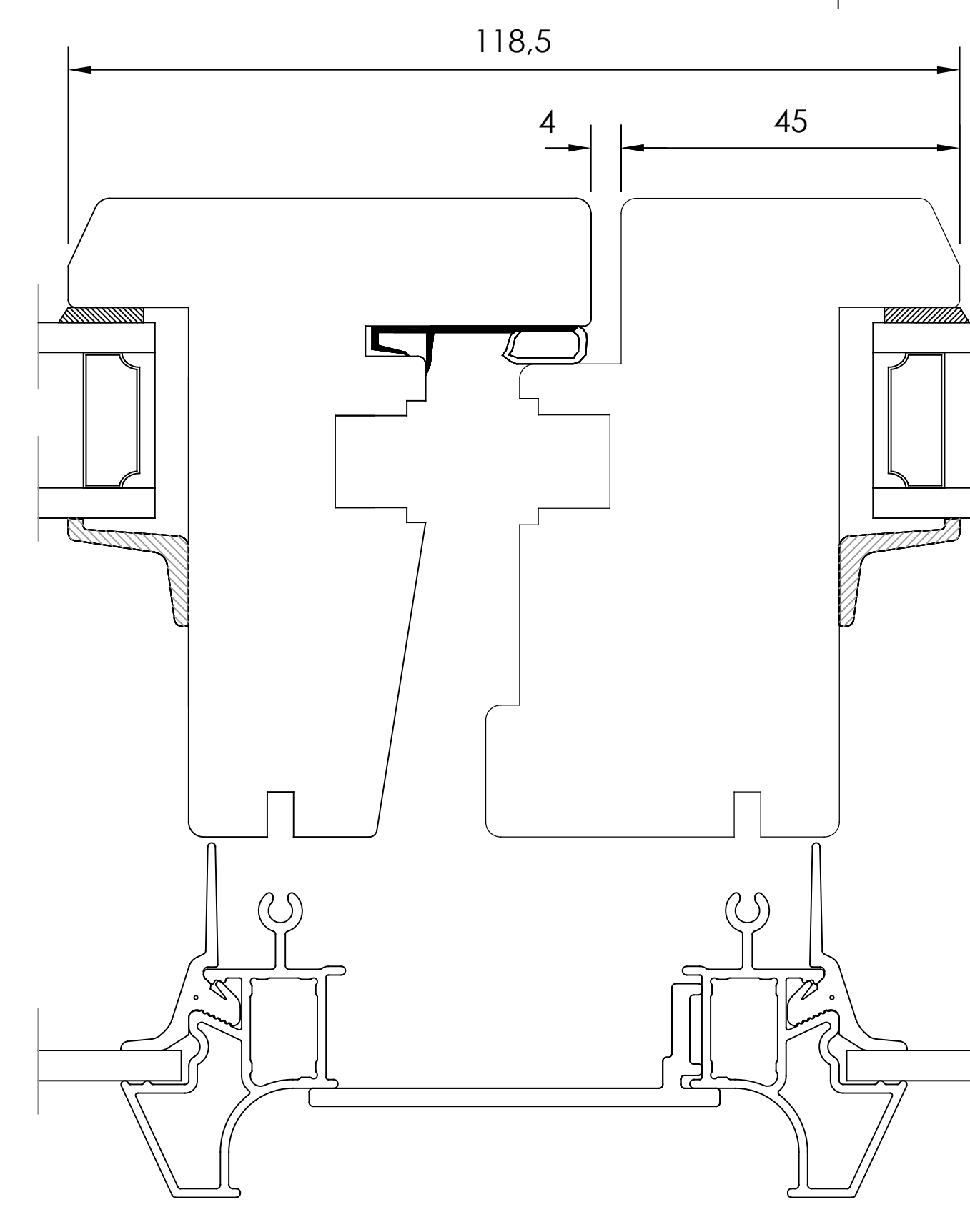

**HORIZONTAL CS OPTION**  
- Two horizontal abutting sashes.

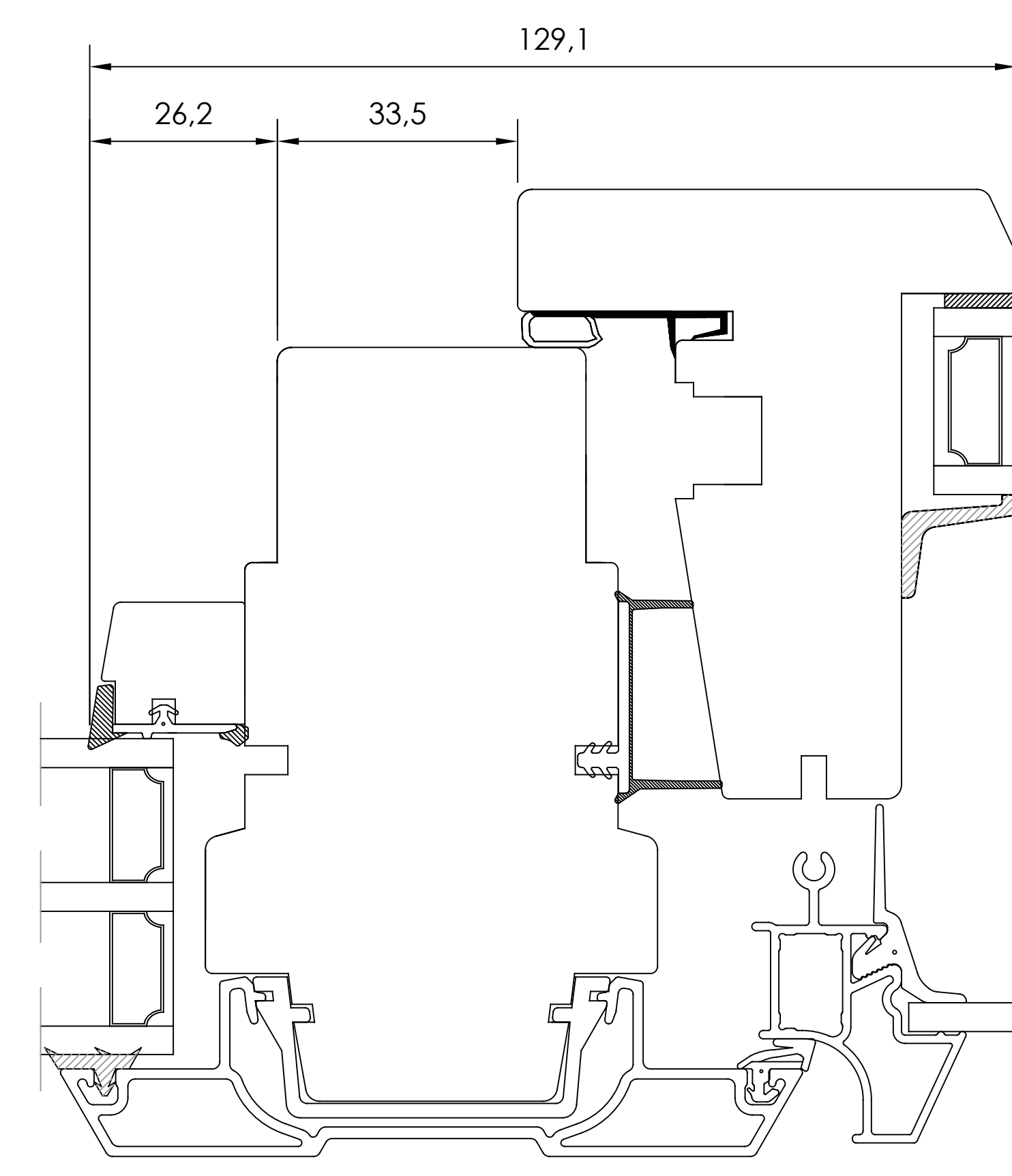

**HORIZONTAL CS OPTION**  
- One glass in fixed frame, the other in sash with side hung fittings and kipp-dreh function.

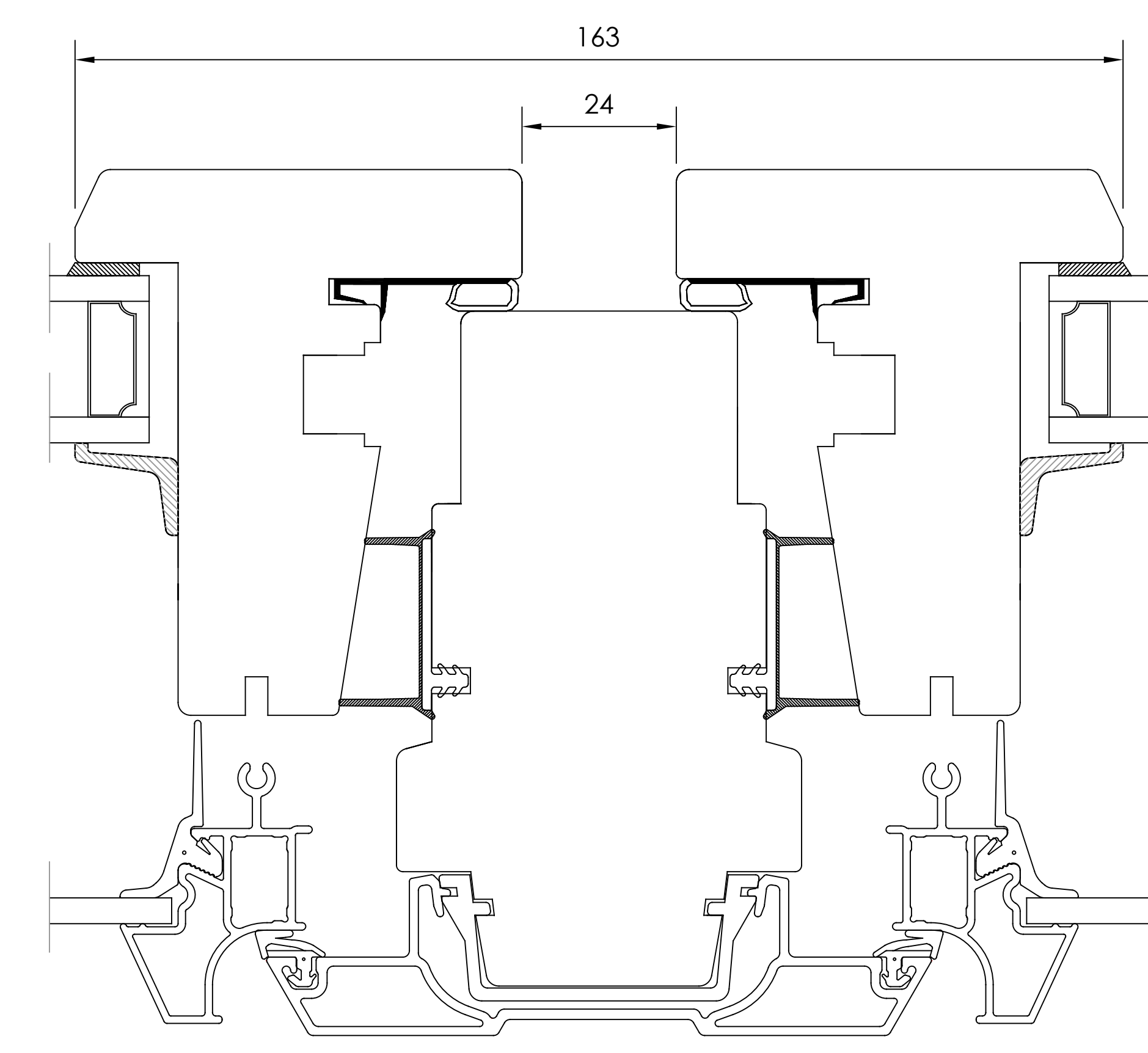

**HORIZONTAL CS OPTION**  
- Two horizontal sashes with middle post.

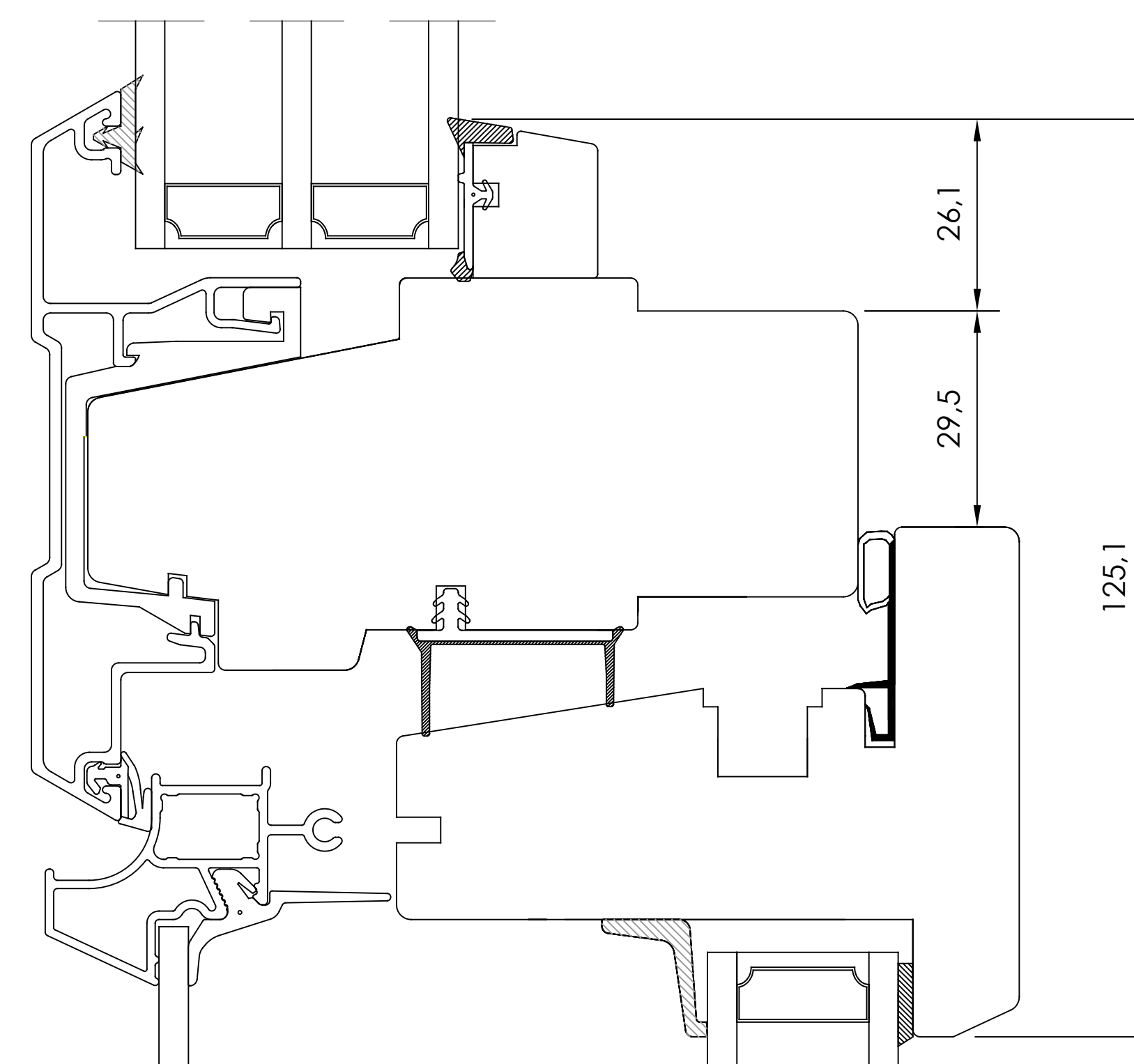

**VERTICAL CS OPTION**  
- Top glass in frame and bottom glass in sash with side hung fittings and kipp-dreh function.

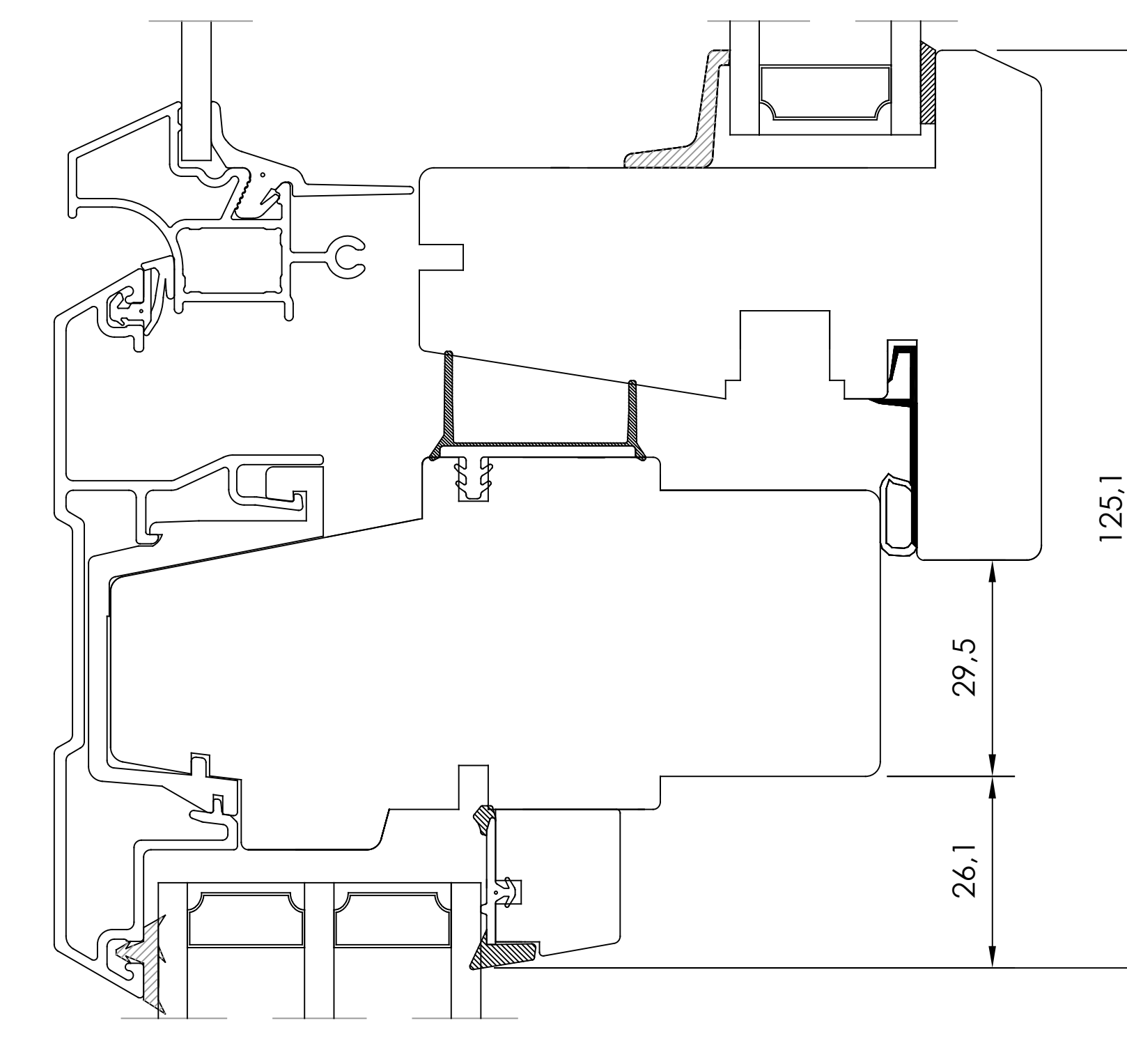

**VERTICAL CS OPTION**  
- Top glass in sash with side hung fittings and kipp-dreh function, bottom glass in frame.

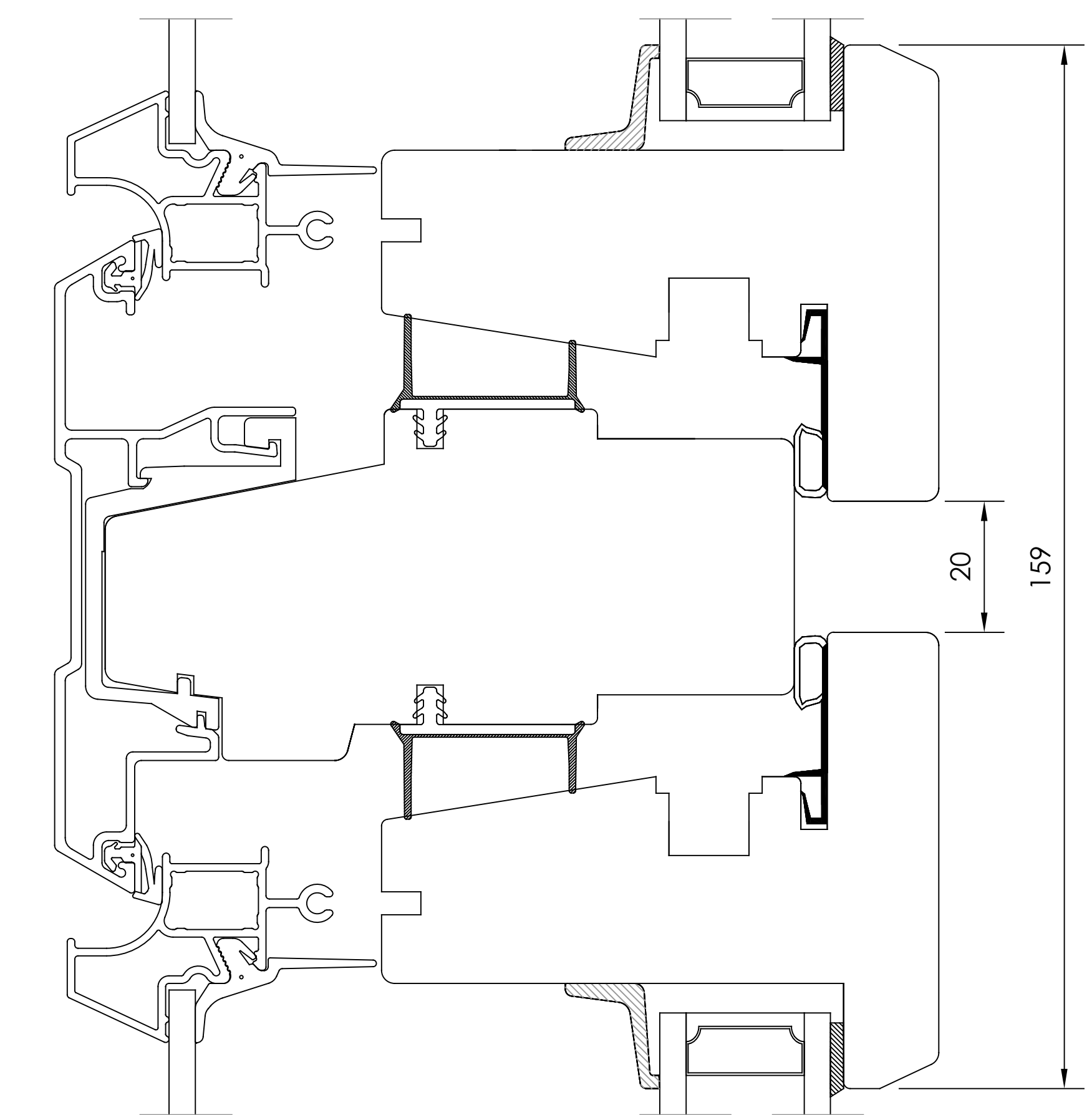

**VERTICAL CS OPTION**  
- Top and bottom glass in sash with side hung fittings and kipp-dreh function, a middle post inbetween.

**VERTICAL CS OPTION**  
- Norwegian nose.

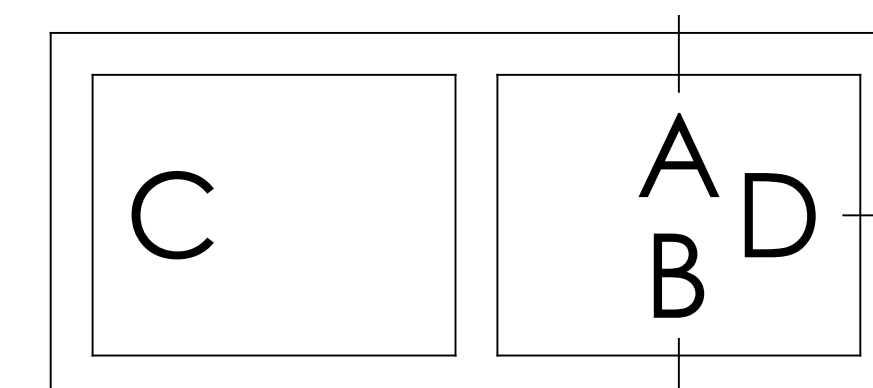
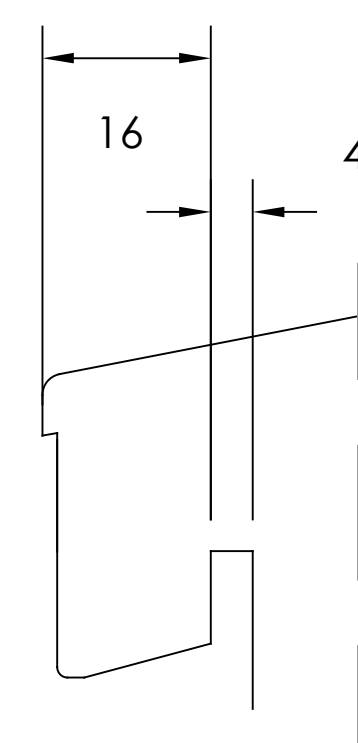

**CS = CROSS SECTION**

Item	No.	Description	Drawingnumber	Articlenumber
Revision notification			Revised by	Revised date
Revision description				
Description		Window, Inward opening 2+1 ECO	Created by TE	Created date 2020-08-04
Material			General tolerance acc. to ISO2768-1	Processing code
Included in product		Inward	Included in product family Bottom hung, Side Hung, Tilt & Turn	Article number

**INWIDO**  
Great Windows & Doors

Draw view

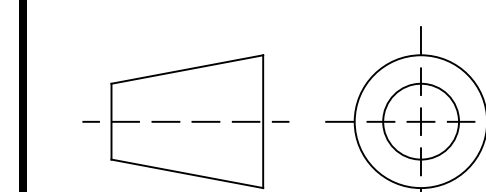

Scale  
1:2

Size  
A3

Drawing number  
40-37-W53

Revision no.  
(A)